

SEK-19 SV HT MA LP ANG29 26P PL2 VC/RE

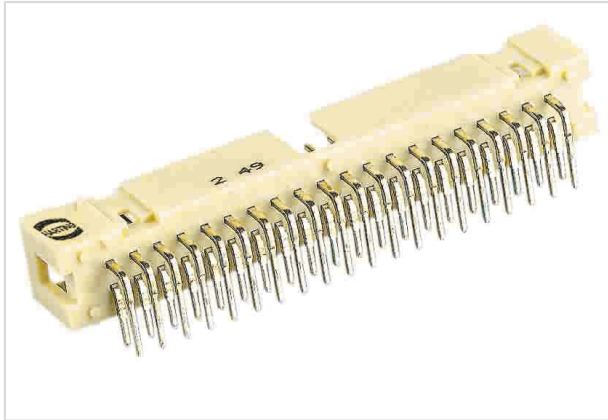

Image is for illustration purposes only. Please refer to product description.

Part number	09 19 526 6323 740
Specification	SEK-19 SV HT MA LP ANG29 26P PL2 VC/RE
HARTING eCatalogue	https://b2b.harting.com/09195266323740

Identification

Category	Connectors
Series	SEK Low-profile
Element	Male connector
Description of the contact	Angled

Version

Termination method	Reflow soldering termination (THR)
Connection type	PCB to cable Motherboard to daughtercard
Number of contacts	26
Termination length	2.9 mm
Pack contents	Tape & reel

Technical characteristics

Contact rows	2
Contact spacing (termination side)	2.54 mm
Rated current	1 A
Insulation resistance	$>10^9 \Omega$
Contact resistance	$\leq 20 \text{ m}\Omega$
Limiting temperature	-55 ... +125 °C (during reflow soldering max. +240 °C for 60 s)
Insertion and withdrawal force	$\leq 52 \text{ N}$
Performance level	2 acc. to IEC 60603-13
Mating cycles	≥ 250



Pushing Performance
Since 1945

Technical characteristics

Test voltage $U_{r.m.s.}$	1 kV
Isolation group	II ($400 \leq CTI < 600$)

Material properties

Material (insert)	Thermoplastic resin (PCT)
Colour (insert)	Beige
Material (contacts)	Copper alloy
Surface (contacts)	Noble metal over Ni Mating side Sn over Ni Termination side
Material flammability class acc. to UL 94	V-0
RoHS	compliant
ELV status	compliant
China RoHS	e
REACH Annex XVII substances	Not contained
REACH ANNEX XIV substances	Not contained
REACH SVHC substances	Not contained
California Proposition 65 substances	Yes
California Proposition 65 substances	Lead Nickel
Requirement set with Hazard Levels	R26

Specifications and approvals

Specifications	IEC 60603-13
UL / CSA	UL 1977 ECBT2.E102079 CSA-C22.2 No. 182.3 ECBT8.E102079

Commercial data

Packaging size	280
Net weight	5.05 g
Country of origin	Romania
European customs tariff number	85366990
GTIN	5713140037557
eCl@ss	27460201 PCB connector (board connector)

Current carrying capacity

The current carrying capacity of the connectors is limited by the thermal load capability of the contact element material including the connections and the insulating parts. The derating curve is therefore valid for currents which flow constantly (non-intermittent) through each contact element of the connector evenly, without exceeding the allowed maximum temperature.

Measuring and testing techniques acc. to IEC 60512-5-2



- ① Temperature raise
- ② Derating curve
- ③ Derating curve 80%

Cross section of solder termination



Reel dimensions

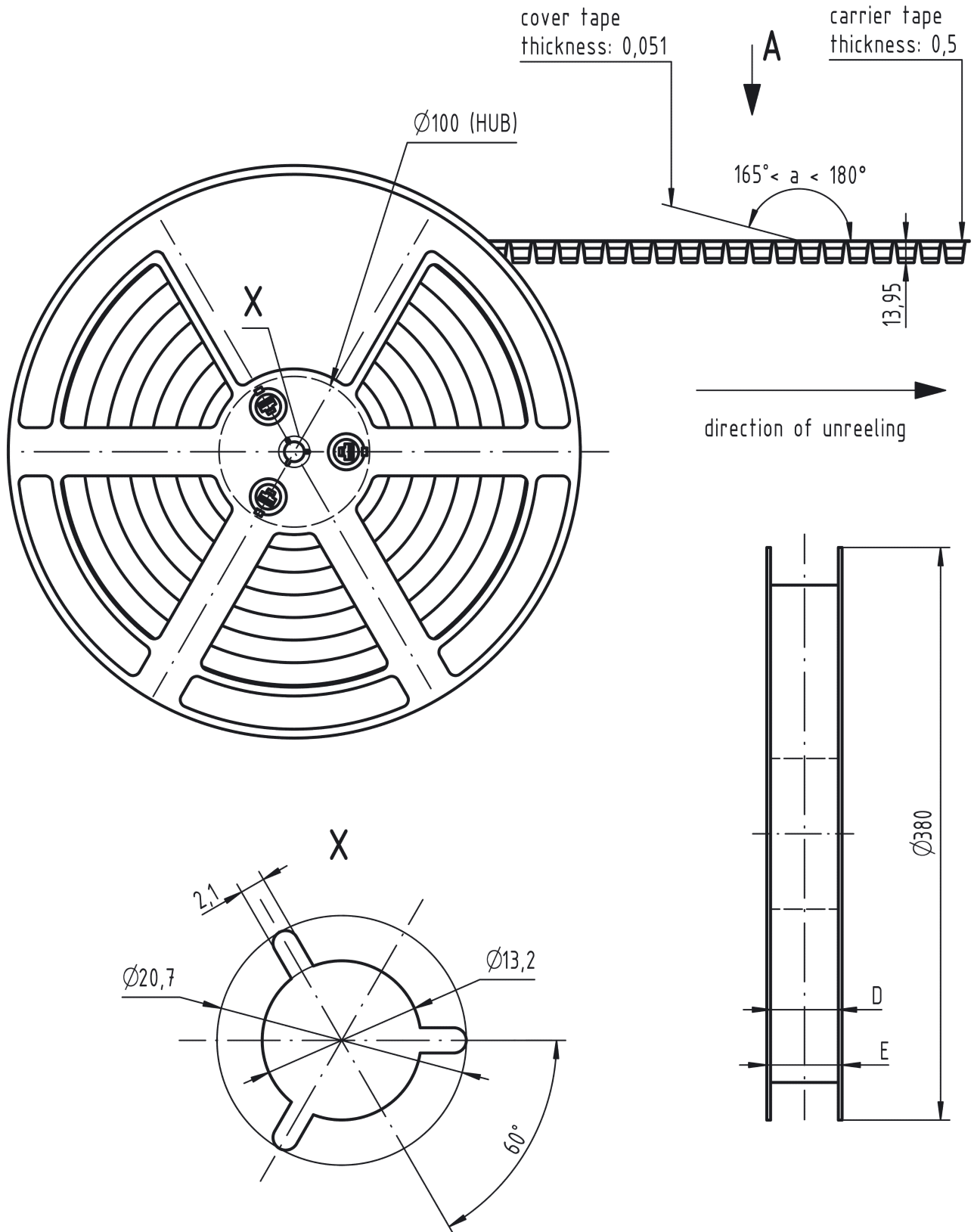

Tape layout & packaging

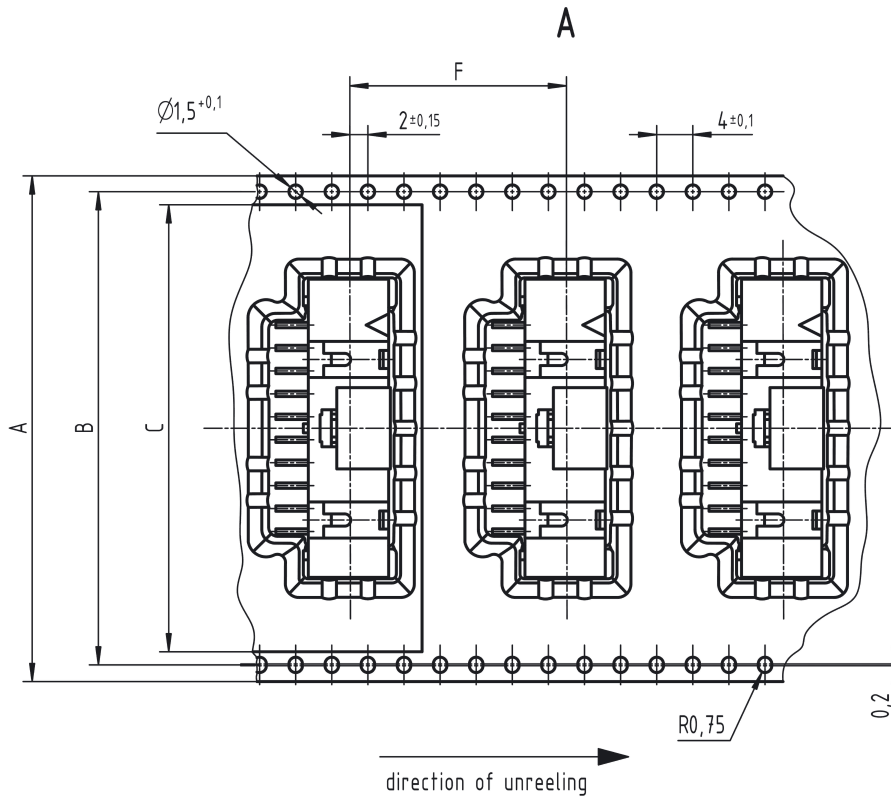

contacts	A	B	C	D	E	F	-trailer- number of empty cavities	number of connector per reel	-leader- number of empty cavities
40	72	68,4	65,5	73	78	24	14	280	16
34	72	68,4	65,5	73	78	24	14	280	16
30	56	52,4	49,5	57	62	24	14	280	16
26	56	52,4	49,5	57	62	24	14	280	16
20	56	52,4	49,5	57	62	24	14	280	16
16	44	40,4	37,5	45	50	24	14	280	16
14	44	40,4	37,5	45	50	24	14	280	16
10	44	40,4	37,5	45	50	24	14	280	16
6	32	28,4	25,5	33	38	24	14	280	16